

**Buck chopper
Fast Trench + Field Stop IGBT®
Power Module**

**$V_{CES} = 1200V$
 $I_C = 400A @ T_c = 80^\circ C$**

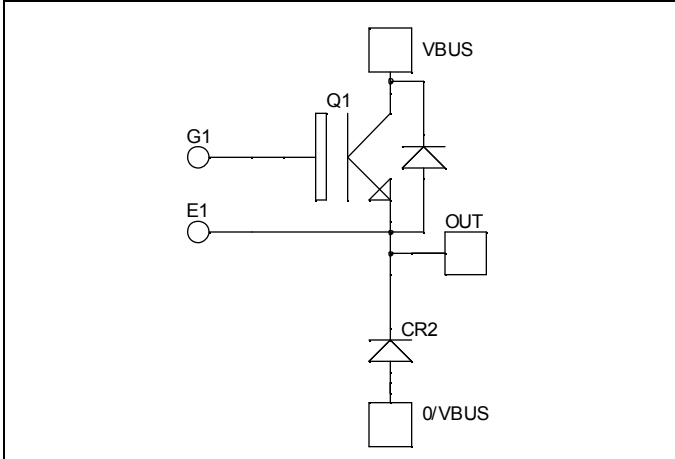

Application

- AC and DC motor control
- Switched Mode Power Supplies

Features

- Fast Trench + Field Stop IGBT® Technology
 - Low voltage drop
 - Low tail current
 - Switching frequency up to 20 kHz
 - Soft recovery parallel diodes
 - Low diode VF
 - Low leakage current
 - Avalanche energy rated
 - RBSOA and SCSOA rated
- Kelvin emitter for easy drive
- Very low stray inductance
 - Symmetrical design
 - M5 power connectors
- High level of integration

Benefits

- Stable temperature behavior
- Very rugged
- Direct mounting to heatsink (isolated package)
- Low junction to case thermal resistance
- Easy paralleling due to positive TC of VCEsat
- Low profile
- RoHS Compliant

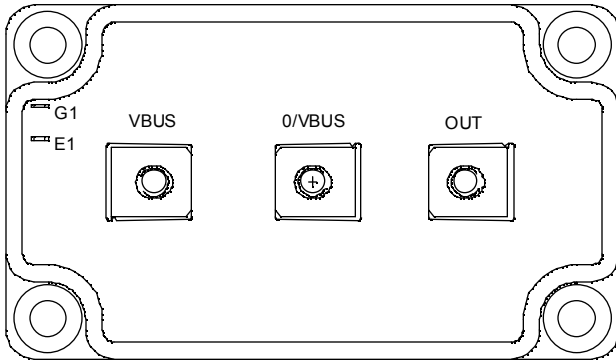

Absolute maximum ratings

Symbol	Parameter	Max ratings	Unit
V_{CES}	Collector - Emitter Breakdown Voltage	1200	V
I_C	Continuous Collector Current	$T_c = 25^\circ C$	560 *
		$T_c = 80^\circ C$	400
I_{CM}	Pulsed Collector Current	$T_c = 25^\circ C$	800
V_{GE}	Gate - Emitter Voltage	± 20	V
P_D	Maximum Power Dissipation	$T_c = 25^\circ C$	1785
RBSOA	Reverse Bias Safe Operating Area	$T_j = 125^\circ C$	800A @ 1100V

* Specification of IGBT device but output current must be limited to 500A to not exceed a delta of temperature greater than 100°C for the connectors.



CAUTION: These Devices are sensitive to Electrostatic Discharge. Proper Handling Procedures Should Be Followed. See application note APT0502 on www.microsemi.com

All ratings @ $T_j = 25^\circ\text{C}$ unless otherwise specified

Electrical Characteristics

Symbol	Characteristic	Test Conditions	Min	Typ	Max	Unit	
I_{CES}	Zero Gate Voltage Collector Current	$V_{GE} = 0\text{V}$, $V_{CE} = 1200\text{V}$			750	μA	
$V_{CE(sat)}$	Collector Emitter Saturation Voltage	$V_{GE} = 15\text{V}$ $I_C = 400\text{A}$	$T_j = 25^\circ\text{C}$ $T_j = 125^\circ\text{C}$	1.4 2.0	1.7 2.1	V	
$V_{GE(th)}$	Gate Threshold Voltage	$V_{GE} = V_{CE}$, $I_C = 4\text{mA}$		5.0	5.8	6.5	V
I_{GES}	Gate – Emitter Leakage Current	$V_{GE} = 20\text{V}$, $V_{CE} = 0\text{V}$			800	nA	

Dynamic Characteristics

Symbol	Characteristic	Test Conditions	Min	Typ	Max	Unit
C_{ies}	Input Capacitance	$V_{GE} = 0\text{V}$		28		nF
C_{oes}	Output Capacitance	$V_{CE} = 25\text{V}$		1.6		
C_{res}	Reverse Transfer Capacitance	$f = 1\text{MHz}$		1.2		
$T_{d(on)}$	Turn-on Delay Time	Inductive Switching (25°C) $V_{GE} = \pm 15\text{V}$ $V_{Bus} = 600\text{V}$ $I_C = 400\text{A}$ $R_G = 1.2\Omega$		260		ns
T_r	Rise Time			30		
$T_{d(off)}$	Turn-off Delay Time			420		
T_f	Fall Time			80		
$T_{d(on)}$	Turn-on Delay Time	Inductive Switching (125°C) $V_{GE} = \pm 15\text{V}$ $V_{Bus} = 600\text{V}$ $I_C = 400\text{A}$ $R_G = 1.2\Omega$		290		ns
T_r	Rise Time			50		
$T_{d(off)}$	Turn-off Delay Time			520		
T_f	Fall Time			100		
E_{on}	Turn on Energy	$V_{GE} = \pm 15\text{V}$ $V_{Bus} = 600\text{V}$	$T_j = 125^\circ\text{C}$	40		mJ
E_{off}	Turn off Energy	$I_C = 400\text{A}$ $R_G = 1.2\Omega$	$T_j = 125^\circ\text{C}$	40		

Chopper diode ratings and characteristics

Symbol	Characteristic	Test Conditions	Min	Typ	Max	Unit
V_{RRM}	Maximum Peak Repetitive Reverse Voltage		1200			V
I_{RM}	Maximum Reverse Leakage Current	$V_R = 1200\text{V}$			700 900	μA
I_F	DC Forward Current			400		A
V_F	Diode Forward Voltage	$I_F = 400\text{A}$ $V_{GE} = 0\text{V}$	$T_j = 25^\circ\text{C}$ $T_j = 125^\circ\text{C}$	1.6 1.6	2.1	V
t_{rr}	Reverse Recovery Time	$I_F = 400\text{A}$ $V_R = 600\text{V}$ $di/dt = 4000\text{A}/\mu\text{s}$	$T_j = 25^\circ\text{C}$	170		ns
			$T_j = 125^\circ\text{C}$	280		
Q_{rr}	Reverse Recovery Charge		$T_j = 25^\circ\text{C}$	36		μC
			$T_j = 125^\circ\text{C}$	72		
E_r	Reverse Recovery Energy		$T_j = 25^\circ\text{C}$	20		
		$T_j = 125^\circ\text{C}$	36			

Typical Performance Curve

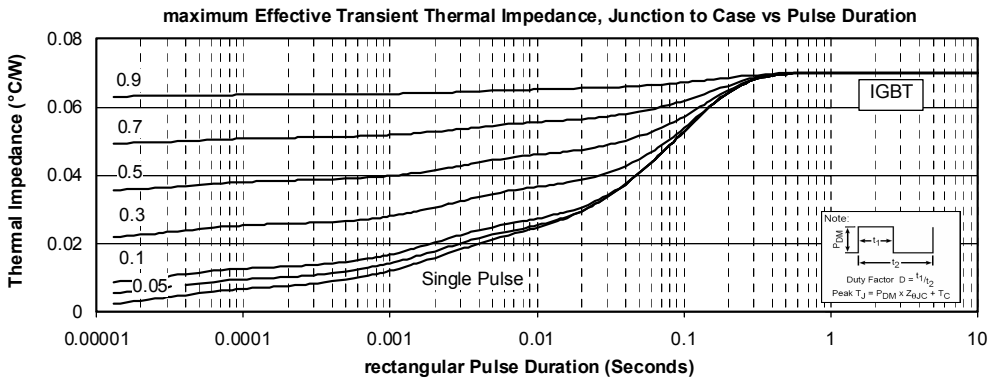
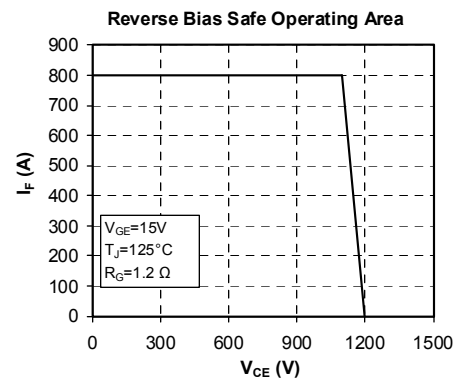
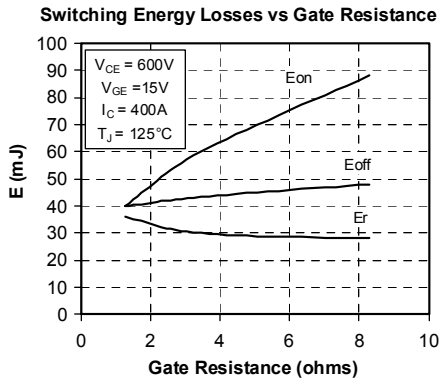
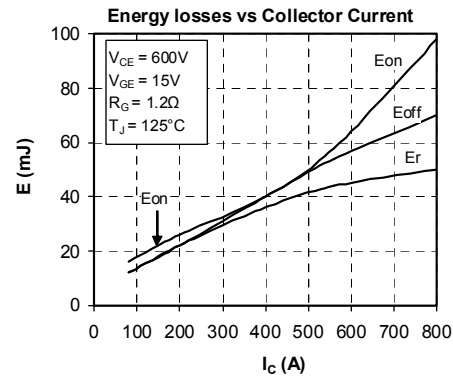
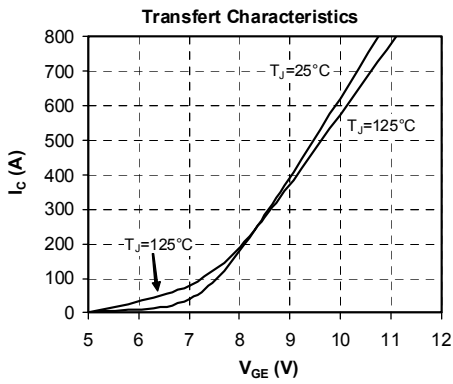
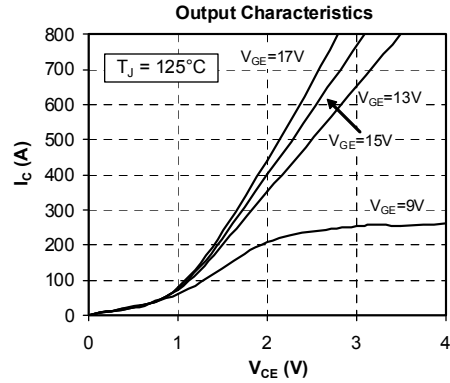
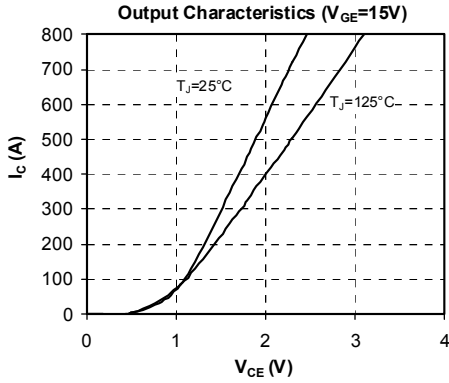

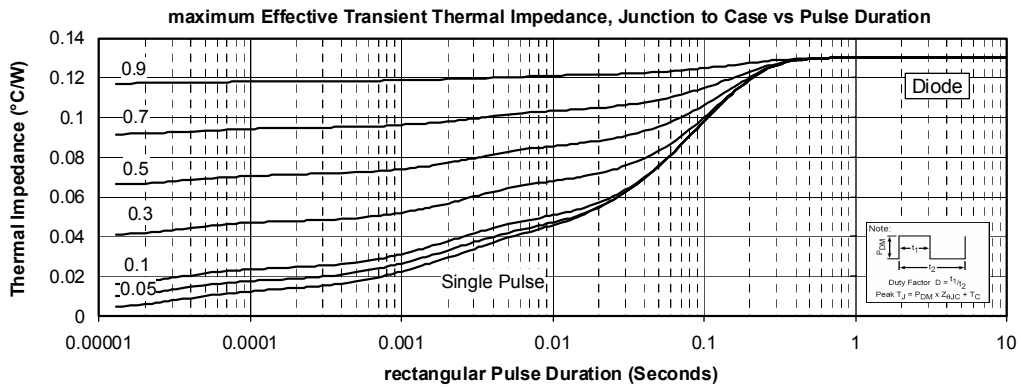
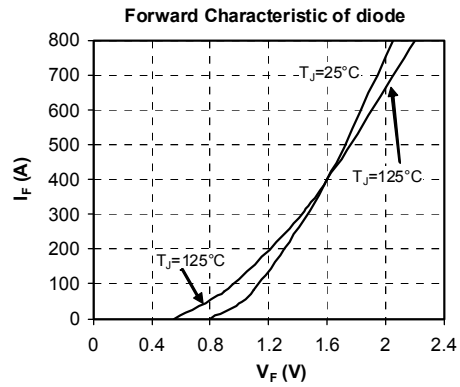
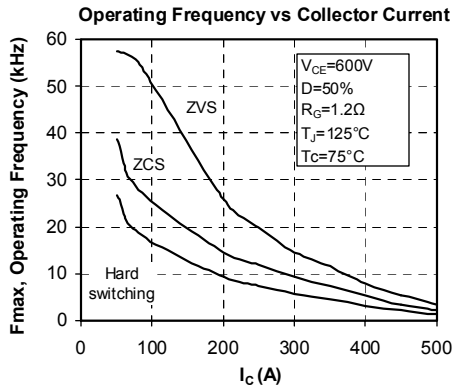

Microsemi reserves the right to change, without notice, the specifications and information contained herein

Microsemi's products are covered by one or more of U.S. patents 4,895,810 5,045,903 5,089,434 5,182,234 5,019,522 5,262,336 6,503,786 5,256,583 4,748,103 5,283,202 5,231,474 5,434,095 5,528,058 and foreign patents. U.S. and Foreign patents pending. All Rights Reserved.